

BILL OF MATERIAL

MARK	QTY	DESCRIPTION	LENGTH	WEIGHT	REMARKS
145M1	1	MISC			
145M1	1	HSS6X6X3/8	6'-1 1/4"	157	A500-GR.B
p5	1	FL1/4"X8"	0'-0"	3	A36
145M2	1	MISC			
145M2	1	HSS6X6X3/8	21'-11 7/8"	567	A500-GR.B
145M3	1	MISC			
145M3	1	HSS6X6X3/8	6'-3 3/4"	163	A500-GR.B
p5	1	FL1/4"X8"	0'-0"	3	A36
145M4	7	MISCS			
145M4	7	HSS6X6X3/8	5'-6 15/16"	1907	A500-GR.B
p5	14	FL1/4"X8"	0'-0"	36	A36
145M5	1	MISC			
145M5	1	HSS6X6X3/8	9'-8 1/4"	204	A500-GR.B
m57	2	HSS4X4X1/4	0'-5 1/2"	11	A500-GR.B
p6	5	FL1/4"X4"	0'-4"	6	A36
p17	1	FL1/4"X4"	0'-6 5/16"	2	A36
p18	1	FL1/4"X2 5/16"	0'-4"	1	A36
p19	1	FL1/4"X4"	0'-6"	2	A36
145M6	1	MISC			
145M6	1	HSS6X6X3/8	10'-5 3/16"	219	A500-GR.B
m58	2	HSS4X4X1/4	0'-7 5/16"	14	A500-GR.B
p14	1	FL1/4"X4 1/4"	0'-6"	2	A36
p16	5	FL1/4"X3 1/8"	0'-4 1/4"	6	A36
p26	1	FL1/4"X4"	0'-7 1/8"	2	A36
p27	1	FL1/4"X2 5/16"	0'-4 1/4"	1	A36
145M7	1	MISC			
145M7	1	HSS6X6X3/8	13'-5 1/4"	347	A500-GR.B
a9	4	LAXX3/8	0'-10"	32	TACK WELD A36
p5	1	FL1/4"X8"	0'-0"	3	A36
TOTAL WEIGHT THIS DRAWING				2784	

PROJECT PHASING

MARK	QTY	PHASE
145M1	1	Phase 1
145M2	1	Phase 1
145M3	1	Phase 1
145M4	7	Phase 1
145M5	1	Phase 1
145M6	1	Phase 1
145M7	1	Phase 1

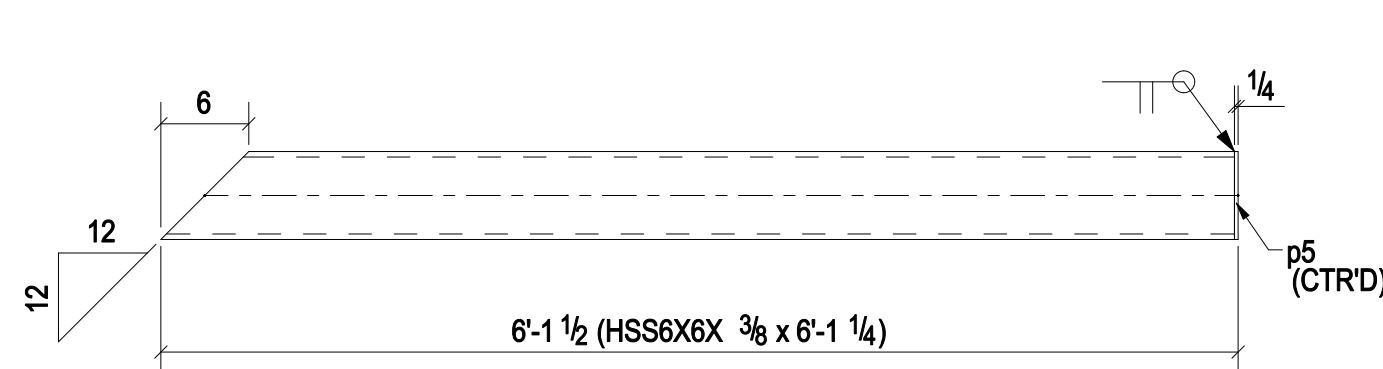

ONE - MISC - 145M1

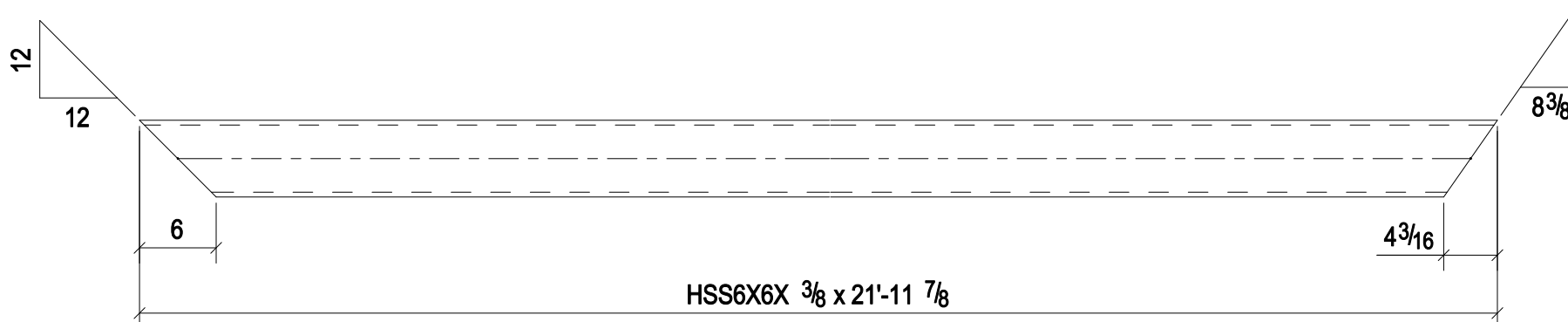

ONE - MISC - 145M2

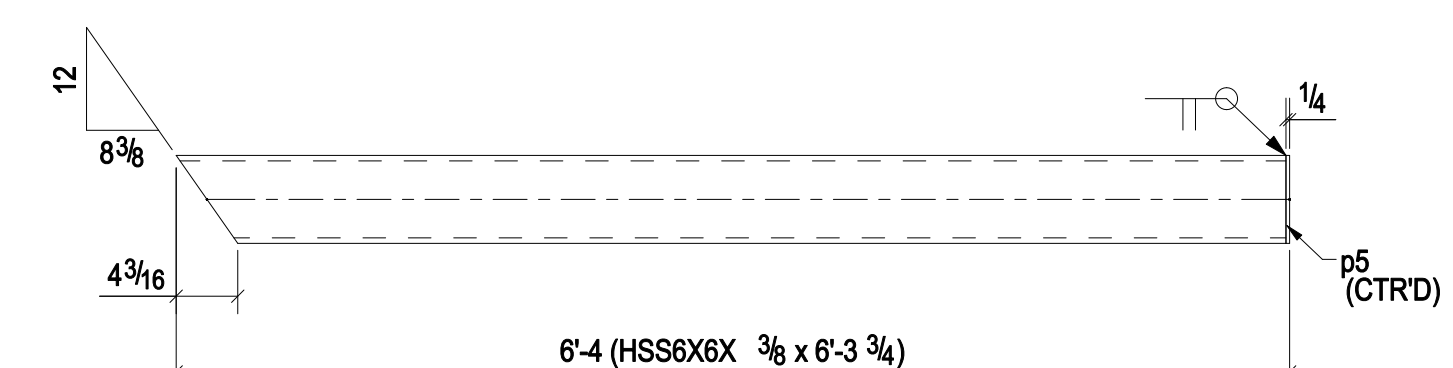

ONE - MISC - 145M3

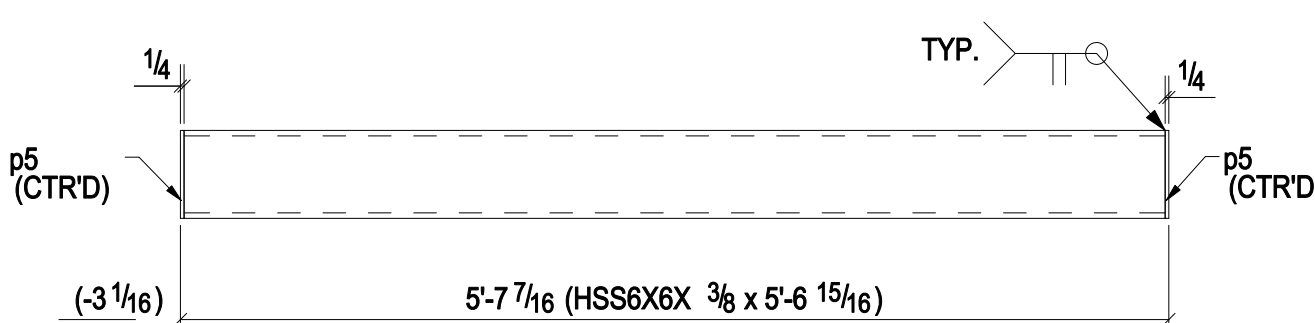

7 - MISCS - 145M4

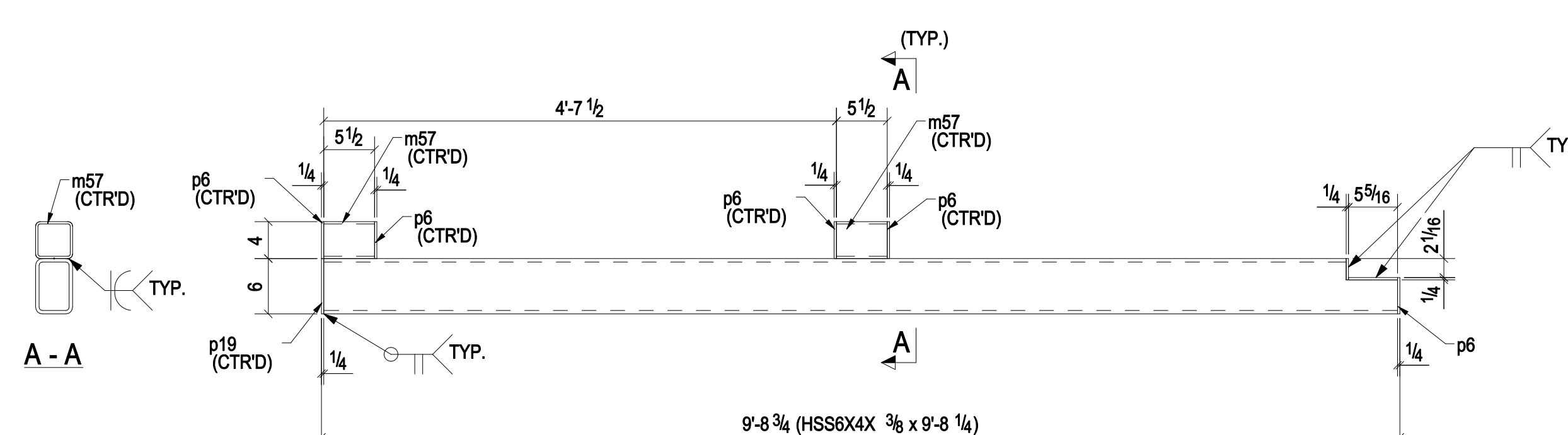

ONE - MISC - 145M5

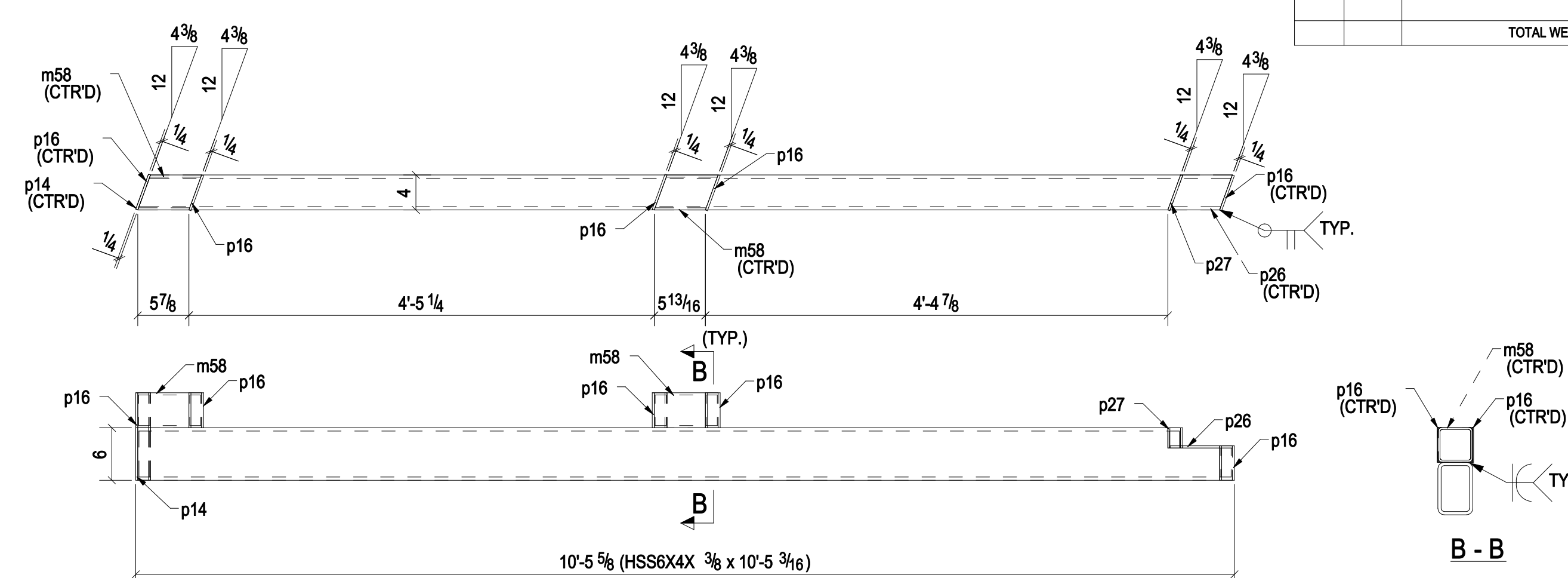

ONE - MISC - 145M6

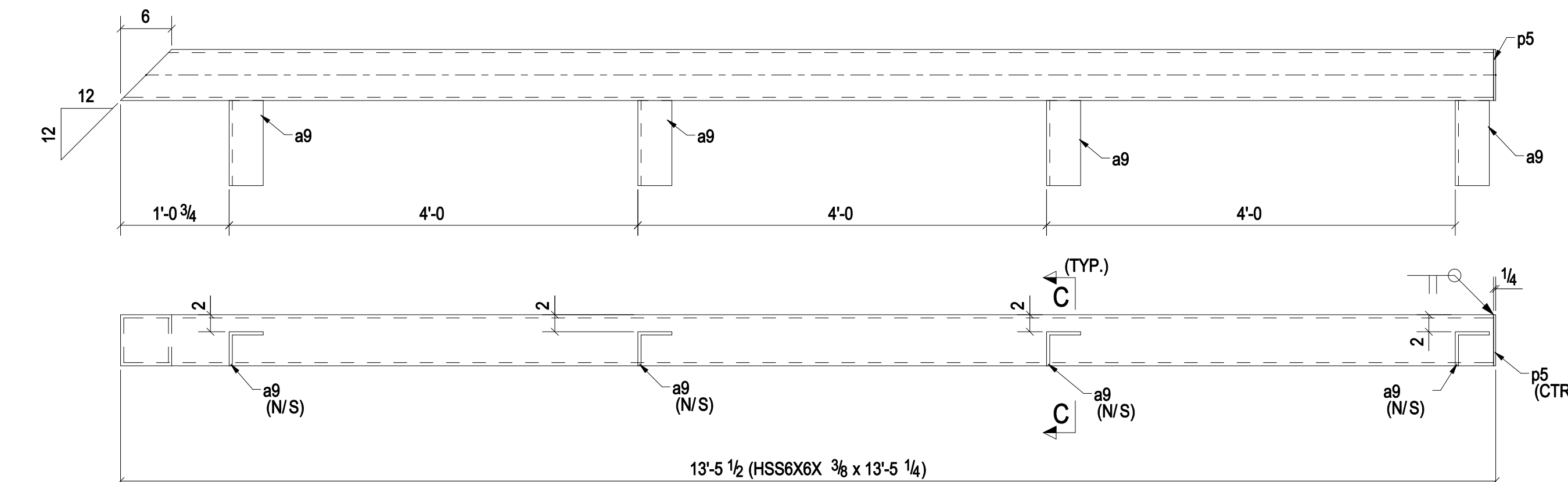

ONE - MISC - 145M7

<p>05/26/14 FOR APPROVAL</p>		<p>PRINT RECORD</p>		<p>SHOP DRAWING DISCLAIMER</p>					
DATE	APP.	SHOP	FIELD	DIST.	COORD.	F.C.	OFFICE		
<p>MATERIAL: A36 UNO</p>						<p>HOLE SIZE: 13/16" Ø UNO</p>	<p>BOLT GRADE: A325-N UNO</p>	<p>MINIMUM WELD: 3/16"</p>	<p>ELECTRODE: E-70XX</p>
<p>ARCH:</p>				<p>JOB NAME & LOCATION:</p>					
<p>ENGR:</p>				<p>CONTR.:</p>					
<p>REF:</p>				<p>JOB: 14-111</p>					
<p>DRAWN BY: ZA</p>		<p>05/26/14</p>		<p>CHECKED BY: SK</p>		<p>05/26/14</p>		<p>SHEET: 145</p>	
<p>MISC</p>									
<p>MODIFIED DATE: 05/28/14</p>		<p>LAST PLOT DATE: 05/28/14</p>		<p>CAD FILENAME: 145</p>					